



# VISUALIZED DIGITAL TOTALIZER

Type:  
**LCM60**

VISUALIZED DIGITAL 6 DIGITS TOTALIZER, WITH INPUT FOR SINGLE DIRECTIONAL COUNTS.

The **LCM 60** counter finds application where there is the necessity to visualize mono-directional counts deriving from electromechanical and logical contacts, proximity and encoder.



## MAIN FEATURES

- Frontal keyboard in polycarbonate (antiscratch, antioil, antacid).
- IP65 protection degree
- Accessible parameters with key software
- Removable terminals connection.
- Execution DIN 48 X 96.
- Recessed assembly.
- Special retaining brackets.

## PROGRAMMABLE PARAMETERS

- 2 conversion factors of the impulses
- Input (Slow / Fast)
- Count (Up / Down / Superior)
- Memory
- Reset key
- Decimal Point

## TECHNICAL FEATURES

• POWER SUPPLY IN ALTERNATE CURRENT	: Single power 24 - 110 - 230 Vac (50 / 60 Hz).
• POWER SUPPLY IN DIRECT CURRENT	: Single power 24 Vdc
• POWER SUPPLY TOLERANCE	: +10% - 15%.
• ABSORPTION	: 2 W - 3 VA.
• OPERATING TEMPERATURE	: -5 °C + 55 °C.
• CLIMATIC CONDITIONS	: U.R. 95 % at 40 °C (without condensate).
• COUNTER AND TOTALIZER VISUALIZATION	: 6 digits, 14 mm high
• MULTIPLICATION FACTOR M1 OF THE IMPULSES IN INPUT	: Programmable from 0,00001 to 9,99999.
• MULTIPLICATION FACTOR M2 OF THE IMPULSES IN INPUT	: Programmable from 1 to 99.
• INPUT TYPE	: Suitable for electromechanical contact and NPN or PNP signals
• COUNT FREQUENCY FOR LOGICAL SIGNALS	: Up to 15 KHz with Duty Cycle=50%.
• MINIMUM TIME FOR COUNT IMPULSES	: 0,25 mSec.
• CUT FREQUENCY FOR ELECTROMECHANICAL INPUTS	: about 30 Hz.
• AUXILIARY INPUTS POWER SUPPLY	: 24 Vdc – 80 mA available on terminals.
• COMMAND INPUTS	: 1 Counter Reset - 1 Inhibit.
• TOTALIZER RESET	: Manual
• PROGRAMMED DATA MEMORY	: static (no battery)

## FRONTAL KEYBOARD DESCRIPTION

 **YELLOW**

The key '**LEFT ARROW**' in normal operating phase visualizes, blinking, all the programmings executed without the limitation of the insertion code. The time of scansion of the programmings is given from the pressure of the same key. It exits automatically from this phase after 5 sec of the last pressure of the same key.

In programming phase it moves the cursor of the figure towards left of a step, than at the beginning it is on the right side first one on the. At the end it resumes from the first one to right.

 **YELLOW**

The key '**UP ARROW**' in normal operating phase visualizes the totalizer of impulses.

In programming phase it increases the value of the blinking figure.

 **BLUE**

The key '**PRG**' pressed for 2 sec. allows to enter in the programming phase, visualizing on display C.0000.

In the programming phase, pressing key 'PRG' impulsively, it exits from the programming phase. The instrument exits automatically from the programming phase, 60 sec. after the pressure of the last key.

 **RED**

The key '**ENT/RES**' in normal phase of counting has the 'RESET' function, with the modalities to it attributed in the programming phase.

In programming phase it confirms and memorizes the visualized data and passes to the successive function. If it has arrived to list end it resumes from the beginning.

## INPUT / OUTPUT DESCRIPTION

**DC POWER**  
(inputs 1-2)

24V DC Power Supply of the instrument.

**AC POWER**  
(inputs 1-2)

AC Power Supply of the instrument; it can be to 24 - 110 - 230 VAC according to demand.

**24 VDC - 100mA**  
(inputs 5 - 6)

24 VDC - 80 mA auxiliary Power Supply that the instrument supply to feed the Encoder and amplified proximity.

**INPUT**  
(input 7)

Input of count adapted for electromechanical and logical contacts, encoder and 3 wires proximity amplified, configurable in Positive (PNP) and Negative (NPN) logic by the dip switches on the rear.

**RESET**  
(input 8)

Input of RESET that executes the reset visualized count showed on display at the moment of its activation.

**INHIBIT**  
(input 9)

Input of count inhibition: when activated it blocks the count of the normal counter and the totalizer.

## PROGRAMMING OF THE OPERATION PARAMETERS

The programmable parameters are divided in two groups and protect with a 4 figures code.

In order to approach the programming, proceed in the following way:

- Press key **PRG** for about 2 sec. On the display appears:

Cod
0000

**GROUP 1** : in order to approach the parameters of group 1, insert code **2357** and press **ENT**

n1
10000

**6 digits multiplier**, programmable from 0,1 to 9.99999. This parameter allows to convert the number of the input impulses, showing them on the display in an other format. If it programmed = 0 it comes reprogrammed automatically to 1. If a value lower than 1 is inserted, it obtains the division of the impulses. Es. I want to divide for 25 the impulses in input; calculation 1 : 25 = 0.04.

**Attention:** the variation of the value of the multiplying modifies automatically the value of the count and the totalizer.

n2 10
-------

**2 digits multiplier**, programmable from 1 to 99. This parameter allows to convert the number of the input impulses, showing them on the display in an other format. If it programmed = 0 it comes reprogrammed automatically to 1.

**Attention:** the variation of the value of the multiplying modifies automatically the value of the count and the totalizer.

In F
In S

### Input Fast - Slow.

This programming allows to predispose the input of count to read signals coming from electromechanical contacts (relay, switches etc.) that introduces false signals, or from logical signals like proximity, encoder, transistor etc.)

**In = F.** predisposes the instrument in order to read to logical signals up to 15 KHz.

**In = S.** predisposes the instrument in order to read to electromechanical contacts up to 25 Hz.

## PROGRAMMAZIONE DEI PARAMETRI DI FUNZIONAMENTO

The programmable parameters are divided in two groups and protect with a 4 figures code.

In order to approach the programming, proceed in the following way:

- Press key **PRG** for about 2 sec. On the display appears:

Cod
0000

**GROUP 2** : in order to approach the parameters of group 1, insert code **2413** and press **ENT** key

MEMon
MEMof

**Active or excluded memory.**

This parameter allows to program the saving of the current counter value during the power off the instrument.

**MEM.on.** = memorization of the count during the power off. When power on the instrument the display will visualize the last present value in the power off phase.

**MEM.of.** = excluded memorization of the count; every time that the instrument comes powered off and then powered on the count comes lost and the instrument restart always from the initial condition.

RESon
RESof

**RESET Key ON / OFF**; this programming enables and disables the RESET function of frontal key RES during the operation of the counter. The disabling does not allow to reset the counter and the totalizer.

**RES.on** = RESET function of key RES **enabled**

**RES.of.** = RESET function of key RES **disabled**

d.p. 0
d.p. 5

**Programming of the Decimal Point of the Counter and the Totalizer.**

This programming allows to add a decimal point to the visualization on the 5 digits, in order to obtain counts with various resolutions.

**d.p. = 0** Decimal Point excluded; visualization 999999

**d.p. = 1** Decimal Point on the second display from right; visualization 99999,9

**d.p. = 2** Decimal Point on the third party display from right; visualization 9999,99

**d.p. = 3** Decimal Point on the quarter display from right; visualization 999,999

**d.p. = 4** Decimal Point on fifth display from right; visualization 99,9999

**d.p. = 5** Decimal Point on sixth display from right; visualization 9,99999

Attention, the Decimal Point is only fictitious, it doesn't realize any conversion.

AP. P.
AP. r.

**Activation mode of the programmed parameters.**

With this programming is possible to activate the executed programmings directly to the exit of the programming or, when exited of the programming, after a RESET (with frontal key or from rear input)

**A.P. = P.** Activation of the parameters to the exit of the programming.

**A.P. = r.** Activation of the parameters to the exit of the programming after a RESET.

Pressing the key  the totalizer of impulses will be visualized for 5 sec.

tot.
999999

The totalizer visualizes all the impulses that the instrument counts from its input IN1.

It can be resetted through frontal key RES only or from RESET input when it is visualized on the display.

# OPERATION DIAGRAMS

## WORKING WITH MANUAL INHIBIT AND RESET

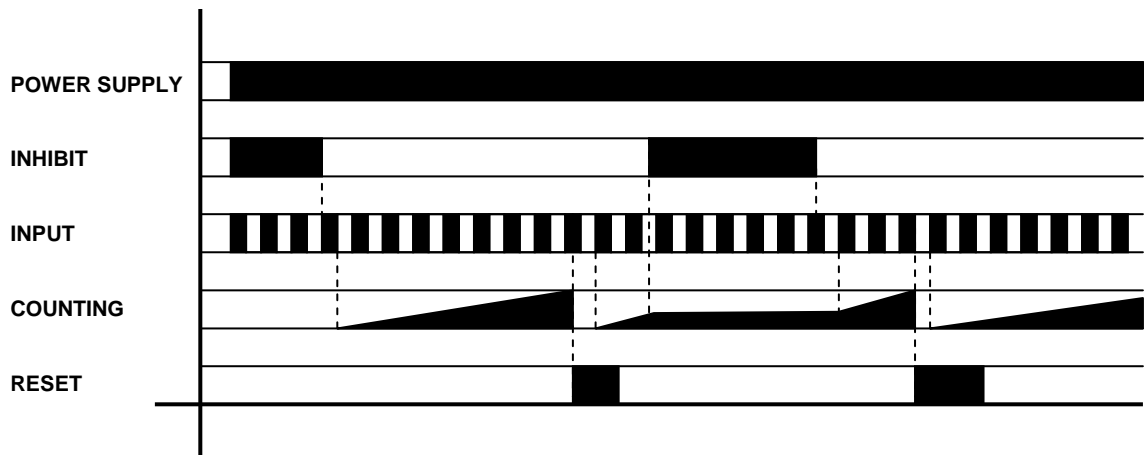



# DECLARATION OF 'CE' CONFORMITY

## CE NORMATIVE CONFORMITY

Borgolavezzaro, October, 03rd 2005

The building firm: **CET s.r.l.**

Head office: **Strada Statale 211, Km 53,3**  
**28071 Borgolavezzaro (No) ITALIA**  
**Tel. 0039 - (0)321 - 885301 Fax. 0039 - (0)321 - 885560**

declare that the products:

type : **Electronic Counter**

model: **LCM 60**

use class: **Industrial**



are in conformity with the following normatives:

**EN55011**  
**ENV50141**  
**ENV50204**  
**EN61000-4-2**  
**EN61000-4-4**

The constructor : **CET s.r.l.**

  
Signature

## CONNECTIONS

NPN PROGRAMMING  PNP PROGRAMMING 

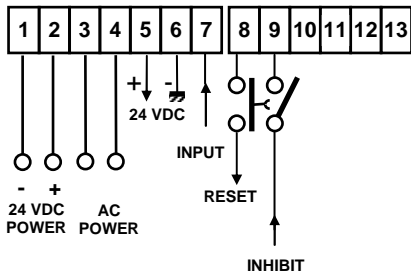

## INPUT SIGNALS

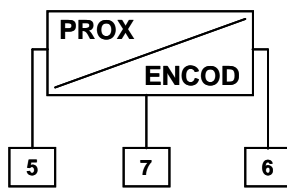

AMPLIFIED PROXIMITY AND ENCODER - 24 Vdc

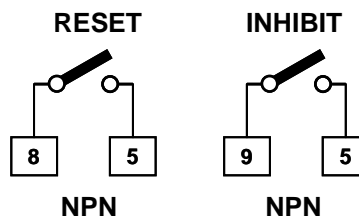
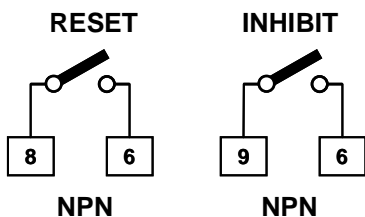
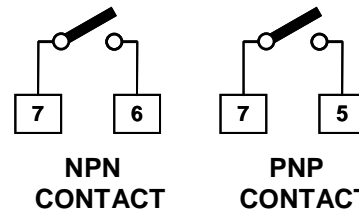
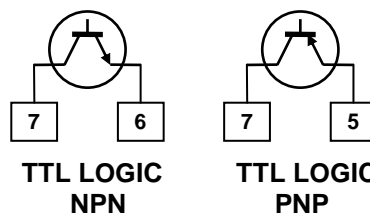

## OVERALL DIMENSIONS (mm)

### FRONT

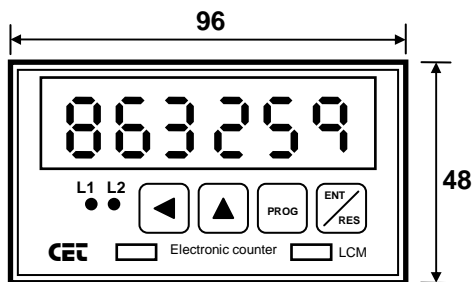

### SIDE

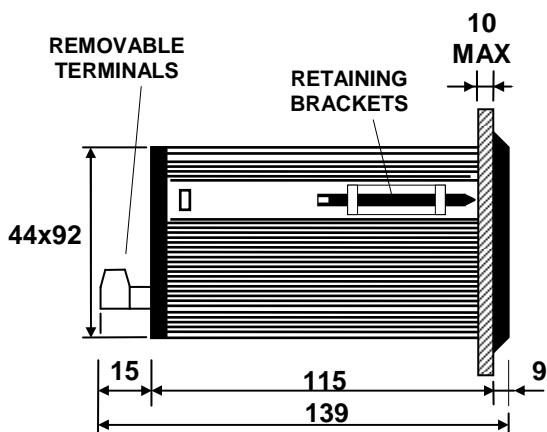

### REAR

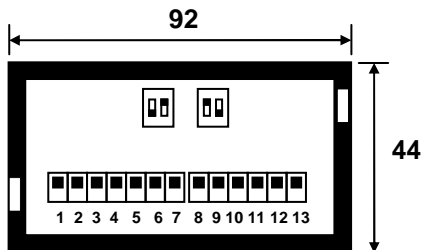

### DRILL TEMPLATE

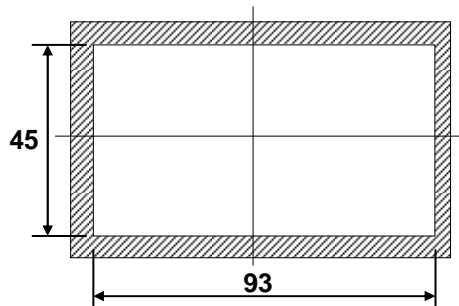

**CET** s.r.l.  
 Strada Statale 211 Km 53,550  
 28071 Borgolavezzaro - NO - ITALY  
 Tel : ++39 0321-885180/885301/885807  
 Fax : ++39 0321-885560  
 info@cet-italy.com  
 www.cet-italy.com

Agent :